

JANUARY 2021

# RULES BOOK

General Competition Guidelines

Competition Format Manual



**IBJJF**

INTERNATIONAL BRAZILIAN JIU-JITSU FEDERATION

[www.ibtjff.com](http://www.ibtjff.com)



***IBJJF***

***INTERNATIONAL BRAZILIAN JIU-JITSU FEDERATION***



# RULE BOOK

IBJJF International Brazilian Jiu Jitsu Federation 2020

## CONTENTS

**04** RULES BOOK

**40** GENERAL COMPETITION GUIDELINES

**48** COMPETITION FORMAT MANUAL

**RULES BOOK**

## **1** ARTICLE 1 – REFEREEING

### **1.1** Authority of Referee

1.1.1 The referee is the highest authority in a match.

1.1.2 The referee ruling on the result of each match is incontestable.

1.1.3 The ruling on the result of a match may only be changed under the following circumstances:

- If the score on the board has been misread;
- If the athlete declared winner submitted his/her opponent using an illegal hold previously unnoticed by the referee.
- If the athlete has been disqualified erroneously for using a legitimate hold. In this case, if the match was interrupted and the athlete disqualified prior to the athlete under attack tapping out, the match shall be restarted at the center of the match area and the attacking athlete shall be awarded two points. In the event that the athlete under attack should tap out prior to the interruption and disqualification, the athlete performing the hold shall be declared the winner.

*Obs: Subjective interpretations of the referee on the awarding of points, advantages or penalties will be final and not subject to change.*

1.1.4 To overturn the outcome of a match, the following conditions should be observed:

- The referee can consult the event's director of refereeing, but the final decision as to whether to overturn or not overturn a result is the referee's to make;
- The director of refereeing should consult the event's center table regarding how the bracket has progressed and may only authorize the overturning of a result if the bracket has not progressed to the next stage.

### **1.2** Refereeing Format

1.2.1 The organizers of the tournament may opt to appoint three referees for a single match whenever they deem it necessary.

- In this case, two corner referees shall be seated in chairs placed at opposing corners of the match area.
- The corner referees bear the same powers as the central referee – and all or any points, advantage points or penalty points awarded must be confirmed by at least two of the three referees.
- Should there be a consensus between the corner referees and the central referee, the corner referees shall remain seated in the chairs at the corners of the match area.
- Should there be a conflict of opinion with the central referee, the corner referees should stand up and signal for points, advantage points or penalty points to be awarded or subtracted, using gestures predefined in this Rules Book.
- Should there be a discrepancy between all three referees on points to be awarded for the same move, the intermediary decision shall count.

*Ex: When one referee awards a guard pass, the second awards an advantage point and the third asks that points be subtracted, the advantage point shall be recorded on the scoreboard.*

- If the referee decides to disqualify an athlete due to the athlete's accumulation of four penalties (serious foul or lack of combativeness), the referee will make the serious penalty gesture before stopping the fight. If at least one of the side referees repeats the gesture, the referee's decision is confirmed and he or she is authorized to stop the fight.

- If the referee decides disqualify an athlete due to the athlete committing a severe foul, he will make the gesture before stopping the fight. If at least one of the side referees repeats the gesture, the referee's decision is confirmed and he or she is authorized to stop the fight.

- When a match ends with a draw in points, advantages and penalties, the central referee will place the two athletes in their starting position (one to his left and one to his right). The referee will take two steps back and make a gesture for the side referees to stand up. After the side referees are standing, the central referee will take a step forward with his right leg. After he or she does so, all three referees raise either their right or left arm in the air. This will signify the athlete each referee believes to be the winner. The central referee will then declare the winner chosen by a majority of the referees.

1.2.2 When deemed necessary, the IBJJF will use two additional referees with access to video replay for the correction of awarded points, advantages or penalties on the scoreboard.

- The correction of any points, advantages or penalties originally awarded by the central referee will only happen in the event of agreement between the two additional referees with access to the video replay.

- After the two referee's with access to the video replay, have reached an agreement on how to correctly adjust the current score, they will communicate the decision via the radio system.

- The central and side referees cannot contest the decision reached by the two referee's with access to the video replay.

### **1.3 Referee Duties**

1.3.1 It is a referee's duty to summon the athletes into the match area to initiate the match.

1.3.2 It is a referee's duty to do a final check to be sure requirements – such as attire, hygiene, etc. – are being met. Should an athlete not meet any of the requirements, it is the referee's duty to determine whether the requirement can be met within a determined amount of time.

1.3.3 It is a referee's duty to position the athletes in the match area prior to the match.

- Points awarded to the athlete on the referee's right shall be signaled using the referee's right arm, which is distinguished from the left arm by a green and yellow armband, indicating the points should be marked on the green and yellow section of the scoreboard.

- Points awarded the athlete on the referee's left shall be signaled using the referee's left arm, which does not bear an armband, and the points will be marked on the uncolored section of the scoreboard.

1.3.4 It is a referee's duty to position the athletes according to the color of their gis.

- Should both athletes be wearing gis of the same color, the first athlete summoned shall be positioned on the referee's right and be provided a green and yellow belt for identification, to be worn in addition to the belt already fastened around his/her waist.

- If one athlete is wearing a white Gi and the other is wearing a royal blue gi, the athlete in royal blue shall be positioned on the referee's right.

- If one athlete is wearing a black Gi and the other athlete is wearing a royal blue gi, the athlete in royal blue shall be positioned on the referee's right.

- If one athlete is wearing a black Gi and the other athlete is wearing a white gi, the athlete in black shall be positioned on the referee's right.

1.3.5 It is a referee's duty to call a start to the match.

1.3.6 It is a referee's duty to intervene in a match when he/she deems it necessary.

*Obs: When the referee stops the fight for any reason, the athletes must maintain their current position to the best of their ability.*

1.3.7 It is a referee's duty to make sure the athletes fulfill their obligation to compete within the combat area.

- When  $\frac{2}{3}$  of the athletes' bodies are outside the combat area in a stabilized position on the ground, the referee should stop the match and, noting the position of each athlete, restart the match at the center of the match area with the athletes in positions identical to those they were in at the moment of stoppage.

- While standing, one of the athletes steps into the safety area (unless a takedown attempt has already been initiated), or when  $\frac{2}{3}$  of the athletes' bodies are outside the combat area during not-yet-stabilized ground fighting, the referee shall interrupt the match and stand both athletes up in the center of the combat area.

- When an athlete has a submission hold in place in the outlying safety area, the referee should not interrupt the match.

- When an athlete has a submission hold in place and the opponent defends by moving to outside the outlying safety area, the referee should stop the match and restart the match at the center of the match area with the athletes standing. In this case, when the referee deems it clearly apparent the athlete under attack initiated the movement that led to exiting the match area, he/she shall signal for 2 (two) points to be added to the score of the athlete performing the submission hold, as described in item 3.1.1.

- When one athlete takes his opponent to the outlying safety area while trying to stabilize a scoring position, the referee shall wait, whenever possible, for an athlete to stabilize the position for 3 seconds before stopping the fight. If this happens, the referee will give the points and then restart the fight in the center of the combat area.

- Points or advantages will be assessed for counting up until the safety area and any movements performed outside the safety area will not be eligible for counting.

- When the fight exits the combat area due to the movement of an athlete attacking a submission in hold, the referee will not mark two points after stopping the fight. Instead, the referee may give an advantage depending on the proximity of the submission, while respecting the rules of advantages (Article 5<sup>th</sup>).

1.3.8 It is a duty of referees overseeing under-12-years-old-division matches to protect the athlete's spinal column by positioning themselves behind the child when lifted off the ground by the opponent, as in the case of a triangle or closed guard.

1.3.9 It is a referee's duty to signal every or any penalty, advantage or point scored by each athlete.

1.3.10 It is up to the referee to punish and disqualify athletes.

- When the situation envisaged in item 6.2.2 (V – When an athlete performs an unintentional movement that puts their opponent in a penalizable position) arises and neither athlete has a submission in hold, the referee should stop the fight and replace the athletes in regular position. The referee will then restart the fight, punishing the infractor.

- Whenever the situation depicted in picture 11 of item 6.2.3 (Single-leg with head on the outside) arises, by attempt to takedown or any other move coming from the ground, with the athletes on they knees or with a sweep motion, the referee shall act in the following way:

- For juveniles and younger divisions and white belts, the referee will stop the fight and restart the match with both athletes standing. No penalties will be given to either athlete.

- For the other divisions the referee shall not interfere with the match.

1.3.11 It is a referee's duty to summon medical staff to the match area.

1.3.12 It is a referee's duty to call an end to the match upon reaching regulation time.

1.3.13 It is a referee's duty to announce the result of the match.

1.3.14 It is a referee's duty to raise the arm of the winner of the match and only that of the winner, even in the event of two athletes from the same academy coming to an agreement designating the match result.

#### **1.4 Referee Gestures and Verbal Commands**

1.4.1 Referees shall use an array of gestures and verbal commands to communicate with the athletes and table officials during the match. Hereunder the gestures and verbal commands are listed according to match circumstances:

##### **MATCH CIRCUMSTANCES:**

Summon athletes to match area.

##### **GESTURE:**

Arms raised to shoulder height and bent at 90-degree angle with palms of hands facing inwards, motioning by extending arms and returning to initial position.

##### **VERBAL COMMAND:**

—



##### **MATCH CIRCUMSTANCES:**

Start of match.

##### **GESTURE:**

Arm extended forward and then lowered to point vertically toward the ground.

##### **VERBAL COMMAND:**

COMBATE! (com-ba-tchee)



##### **MATCH CIRCUMSTANCES:**

Interruption of the fight, stopwatch and time out.

##### **GESTURE:**

Arms open and raised at shoulder height.

##### **VERBAL COMMAND:**

PAROU! (pa-row)





**MATCH CIRCUMSTANCES:**

Penalty for lack of combativeness (stalling) or serious foul.

**GESTURE:**

Arm corresponding to the penalized athlete points to the center of his chest followed by raising a clenched fist to shoulder height.

**VERBAL COMMAND:**

LUTE! (lu-tchee) – at the same time point to the chest when there is a lack of combativeness situation. or FALTA! (fal-tah) – at the same time point to the chest when there is a serious foul.

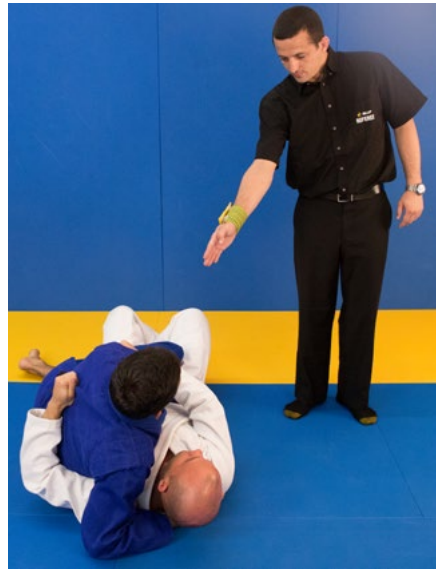

**MATCH CIRCUMSTANCES:**

Penalty for lack of combativeness (stalling) or serious foul when it is not possible for the referee to clearly point at the athlete to be punished.

**GESTURE:**

The referee should lightly touch one of the shoulders of the athlete to be punished followed by raising a clenched fist to shoulder height.

**VERBAL COMMAND:**

LUTE! (lu-tchee) – at the same time touching the shoulder when there is a lack of combativeness situation. or FALTA! (fal-tah) – at the same time touching the shoulder when there is a serious foul situation.

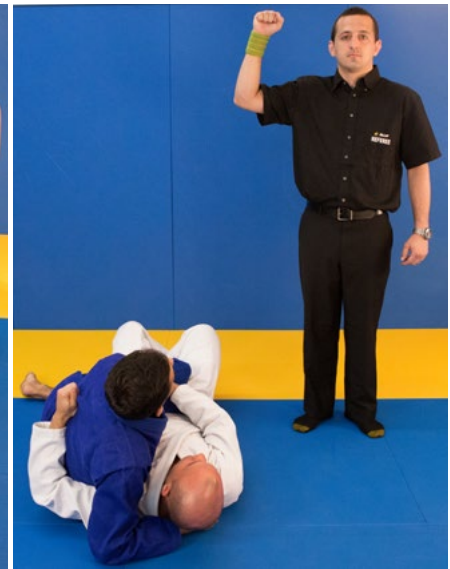

**MATCH CIRCUMSTANCES:**

Disqualification.

**GESTURE:**

Arms over head with forearms crossed and fists clenched, followed by arm corresponding with disqualified athlete pointing to athlete's belt.

**VERBAL COMMAND:**

—

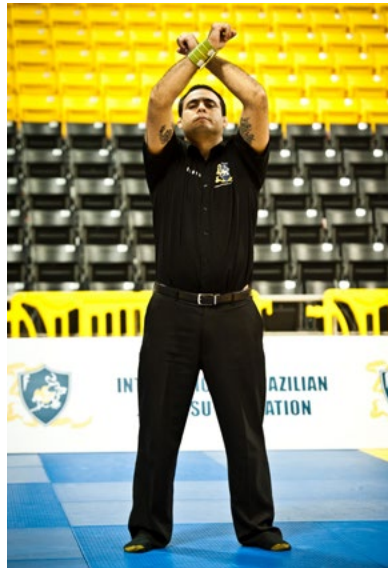

**MATCH CIRCUMSTANCES:**

Advantage.

**GESTURE:**

Arm corresponding with athlete to be awarded advantage point extending parallel to mat with hand open and palm facing downwards.

**VERBAL COMMAND::**

—



**MATCH CIRCUMSTANCES:**

2 (two) points: takedown, sweep, and knee on belly.

**GESTURE:**

Hand of arm corresponding with athlete to be awarded points raised and pointer and middle fingers extended.

**VERBAL COMMAND:**

—



**MATCH CIRCUMSTANCES:**  
3 (three) points: guard pass.

**GESTURE:**  
Hand of arm corresponding with athlete to be awarded points raised and pointer, middle, and ring fingers extended.

**VERBAL COMMAND:**  
—



**MATCH CIRCUMSTANCES:**  
4 (four) points: Mount and back control.

**GESTURE:**  
Hand of arm corresponding with athlete to be awarded points raised and pointer, middle, ring, and pinkie fingers extended.

**VERBAL COMMAND:**  
—



**MATCH CIRCUMSTANCES:**  
Point deduction.

**GESTURE:**  
Arm corresponding with athlete to be deducted points at shoulder height with palm open.

**VERBAL COMMAND:**  
—



**MATCH CIRCUMSTANCES:**

Announcement of match result.

**GESTURE:**

Arm of winning athlete raised while facing judges' table and the arm of losing athlete held downwards.

**VERBAL COMMAND:**

—



**MATCH CIRCUMSTANCES:**

Direct athlete to re-adjust gi.

**GESTURE:**

Arms crossed downwards at waist height, extending arm to indicate athlete's belt.

**VERBAL COMMAND:**

—



**MATCH CIRCUMSTANCES:**

Instruct athlete to remain within match area.

**GESTURE:**

After pointing to the athlete with arms extended towards his/her waist, hand at shoulder height with open palms making a circular motion.

**VERBAL COMMAND:**

–



**MATCH CIRCUMSTANCES:**

Instruct athlete to stand up.

**GESTURE:**

Indicate with extended arm the athlete who must stand up, followed by raising arm to shoulder height.

**VERBAL COMMAND:**

–



**MATCH CIRCUMSTANCES:**

Instruct athlete to return to ground in position appointed by referee.

**GESTURE:**

Arm corresponding with athlete extended to shoulder height, followed by arm pointing diagonally across body toward ground.

**VERBAL COMMAND:**

–



**MATCH CIRCUMSTANCES:**

When an athlete grabs the opponent's sleeves or pant legs with one or more fingers placed inside the garment.

**GESTURE:**

One hand placed on top of the opposite arm, holding the wristband.

**VERBAL COMMAND:**

—



**MATCH CIRCUMSTANCES:**

When a change in point, advantage or penalty-count has been communicated to the central referee by the referee(s) with access to video replay.

**GESTURE:**

Touch the ear with the fingertips twice, pausing between touches.

**VERBAL COMMAND:**

—

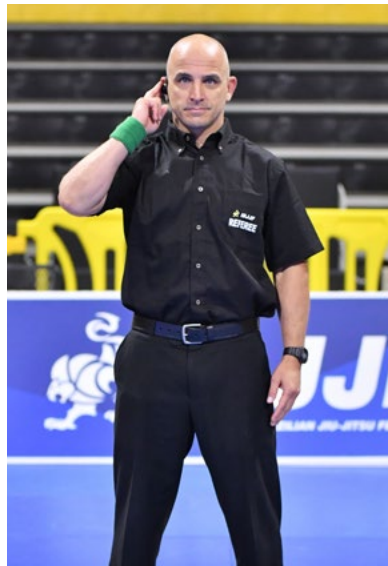

## **2** ARTICLE 2 - RENDERING DECISIONS

Match decisions shall be issued in the following forms:

- » **Submission**
- » **Stoppage**
- » **Disqualification**
- » **Loss of consciousness**
- » **Score**
- » **Referee decision**
- » **Random pick**

### **2.1** **Submission**

- 2.1.1 When an athlete taps twice with his/her hand on the opponent, ground, or his/herself in a clear and apparent manner.
- 2.1.2 When the athlete taps the ground twice with his/her foot, when arms are trapped by opponent.
- 2.1.3 When the athlete verbally withdraws, requesting the match be stopped.
- 2.1.4 When the athlete screams or emits noise expressing pain while trapped in a submission hold.

### **2.2** **Stoppage**

- 2.2.1 When one of the athletes alleges to be suffering from cramps, the opponent shall be declared winner of the match.
- 2.2.2 When the referee perceives that a hold in place may expose the athlete to serious physical injury.
- 2.2.3 When the doctor deems one of the athletes to be unable to continue a match due to injury rendered by the opponent using a legal hold.
- 2.2.4 When an athlete presents bleeding that cannot be contained after being treated by the doctor on 2 (two) occasions, to which each athlete has the right for each injury and should be provided upon the referee's request.
- 2.2.5 When an athlete vomits or loses control of basic bodily functions, with involuntary urination or bowel incontinence.

### **2.3** **Disqualification**

- 2.3.1 When one or both athletes commit a foul addressed in **Article 6**, the referee shall apply the penalties addressed in **Article 7**.

### **2.4** **Loss of Consciousness**

- 2.4.1 The athlete shall be declared to have lost the match upon losing consciousness due to a legal hold applied by the opponent or due to an accident not stemming from an illegal maneuver by the opponent.

*Note: Athletes who lose consciousness because of head trauma should not be allowed to compete again in the same tournament and should be directed to undergo treatment from medical staff.*

### **2.5** **Scoring**

- 2.5.1 The athlete with the most points shall be declared winner when the match has reached regulation time or in the event of the match being stopped due to both athletes suffering injuries.

2.5.2 The referee shall award athletes points according to positions achieved, as shown in the table below.

04 POINTS	03 POINTS	02 POINTS
Mount Back mount Back control	Guard pass	Takedown Sweep Knee on belly

2.5.3 Advantages: When there is a draw in the number of points, the athlete with the most advantage points shall be declared the winner.

2.5.4 Penalties: When there is a draw in the number of points and advantage points, the athlete with the least penalty points counted against him/her shall be declared the winner.

## **2.6 Referee Decisions**

2.6.1 If at the end of a match both athletes have the same number of points, advantage points and penalties, it is the duty of the referee or referees (when there are three referees overseeing a match) to declare a winner.

2.6.2 To determine the winner, the referee should take note of which athlete displayed greater offense during the match and came closest to achieving possible point- or submission-scoring positions.

## **2.7 Random Pick**

2.7.1 In the event of both athletes suffering accidental injury in a final match where the score is tied at the moment of the accident and neither athlete is able to continue in the contest, the result shall be determined by random pick.



### **3** ARTICLE 3 – POINTS SCORING

#### **3.1** Points shall be awarded by the central referee of a match whenever an athlete stabilizes a position for 3 (three) seconds.

3.1.1 When the proper defensive counter for a submission hold results in exiting the match area, the referee shall signal 2 (two) points be awarded to the athlete applying the submission hold (as addressed in item 1.3.7).

#### **3.2** Matches should unfold as a progression of positions of technical control that ultimately result in a submission hold. Therefore athletes who voluntarily relinquish a position, in order to again score points using the same position for which points have already been awarded, shall not be awarded points upon achieving the position again.

#### **3.3** Athletes who arrive at a point-scoring position while caught in a submission hold shall only be awarded points once they have freed themselves from the attack and stabilized the position for 3 (three) seconds.

3.3.1 Should an athlete achieve point-scoring positions while caught in a submission hold but only escapes the hold once no longer in the point-scoring position, will not be awarded points or advantages for those positions.

3.3.2 The 3-second stabilization count for one or several point-scoring positions will be interrupted, when the opponent lock in a submission hold during the count.

When this happens, the athlete will be awarded an advantage for each of the point-scoring positions achieved, regardless of whether the opponent is no longer in the positions once the hold has been escaped from or regulation time has ended.

3.3.3 An athlete who reaches one or more positions (cumulative points) but is being attacked with a submission hold by his/her opponent, shall only be awarded one advantage point if he/she does not escape the attack prior to the end of the match.

#### **3.4** Athletes shall be awarded cumulative points when they progress through a number of point-scoring positions, as long as the three-second positional control from the final point-scoring position is a continuation of the positional control from the point-scoring positions from earlier in the sequence. In this case, the referee shall count only 3 (three) seconds of control at the end of the sequence before signaling the points be scored.

*Ex: Guard pass followed by mount shall add up 7 points (3+4).*

#### **3.5** When both athletes pull guard at the same time, the athlete who achieves top position first is awarded an advantage point.

*Obs: In cases that the athlete achieves the top position by going straight to the side-mount, he will not receive points nor an advantage for the guard pass.*

## 4 ARTICLE 4 – POINT SCORING POSITIONS

### 4.1 Takedown (2 points)



- 4.1.1 When one of the athletes, starting the movement with 2 feet on the ground, causes the opponent to land on his/her back, sideways or seated, establishing top position for 3 (three) seconds.



- 4.1.2 When an athlete forces his/her opponent to the ground on all fours or belly-down, points shall only be awarded once the athlete performing the takedown controls the opponent's back without the requirement of placing hooks and keeping at least one of the opponent's knees on the ground for 3 (three) seconds.
- 4.1.3 If an athlete forces his or her opponent to the ground in the outlying safety area, the athlete performing the takedown should have both feet within the match area when the movement begins. In this case, if the athletes land in a stabilized position, the referee will only stop the match after 3 seconds of stabilization in the position. Then the referee will score the points and restart the match at the center of the match area. The athletes will be placed in the same position they were in when the match was stopped.
- 4.1.4 In a sweep movement, when both athletes remain standing for less than 3 seconds and the athlete on defense throws the opponent to the ground on their back or sideways, or on his knees and controlling the back, shall not be awarded the two points or advantage for the takedown.
- 4.1.5 While in any position starting from guard, where the athletes remain on their feet for 3 seconds, the combat shall then be considered standing combat.

**Note:** *In order to start the 3-second countdown, one of the athletes must have two feet on the ground and the opponent at least one foot on the ground without the knee of the opposite leg touching the mat.*

- 4.1.6 When the opponent has one or two knees on the ground, the athlete performing the takedown will only be awarded points if he/she is standing at the moment the takedown is carried out, unless it is a sweep-defense situation, as described in this article, and meets the 3-second stabilization-count criterion.

**Note:** *No points shall be awarded in situations where the opponent is taken down from their knees, whether initiated in the guard or any other ground-fighting situation.*

- 4.1.7 When the athlete forces his/her opponent to the ground using a single or double-leg takedown and the opponent lands seated and successfully applies a counter-takedown (another takedown), only the athlete performing the counter-takedown shall be awarded the two points when he/she can stabilize this position for 3 (three) seconds.
- 4.1.8 For any takedown technique where the athlete, delivering his/her opponent back-down or sideways on the ground, lands in guard or half-guard and immediately suffers a successful sweep by the opponent, he/she shall be awarded an advantage relating to the takedown and his/her opponent shall be awarded the two points from the sweep.
- 4.1.9 An athlete who takes the opponent down in order to defend a standing back-take, where the opponent has both hooks in place, or one hook in place and neither foot on the ground, will not be awarded the two points or advantage for the takedown. Even after the position has been stabilized for three seconds.
- 4.1.10 An athlete who initiates a takedown before the opponent initiates the guard pull shall be awarded the two points or advantage for the takedown, as described in item 4.1 (Takedown).
- 4.1.11 An athlete who initiates a takedown after the opponent initiates a guard-pull attempt shall not be awarded the two points or advantage for the takedown.
- 4.1.12 When an athlete has a grip on the opponent's pants and the opponent pulls guard, the athlete with the grip on the pants shall be awarded two points for the takedown if he/she stabilizes the top position on the ground for 3 (three) seconds.

**Note:** *If the opponent pulls closed guard and remains suspended in the air, the athlete will have to put the opponent's back on the ground within 3 (three) seconds and stabilize the top position for 3 (three) seconds to be awarded with Takedown points.*

#### 4.2 Guard Pass (3 points)

- When the athlete in top position manages to surmount the legs of the opponent in bottom position (pass guard or half-guard) and maintain side-control or north-south position over him/her for 3 (three) seconds.



SIDE CONTROL



NORTH-SOUTH CONTROL



OPPONENT LYING ON HIS SIDE

**Note 1:** *Guard is defined by the use of one or more legs to block the opponent from reaching side-control or north-south position over the athlete on bottom.*

**Note 2:** *Half-guard is the guard where the athlete on bottom is lying on his/her back or side and has one of the top-positioned athlete's legs trapped, blocking him/her from achieving side- or north-south control over the bottom-positioned athlete for 3 (three) seconds.*

**Note 3:** *The position of the top athlete's legs determines whether it is half-guard or reverse half-guard, according to the following examples:*



**Example 1:** In half-guard with his right leg trapped, his left leg is positioned alongside the right leg of the opponent playing guard.



**Example 2:** In reverse half-guard with his right leg trapped, his left leg is positioned alongside the left leg of the athlete playing guard.

- If while attacking from top position, such as an armbar, for example, the athlete ends up on bottom and does not use his/her legs to prevent the opponent from reaching side-control, no points or advantages shall be awarded for the guard pass, according to the definition of guard.



### 4.3 Knee on Belly (2 points)

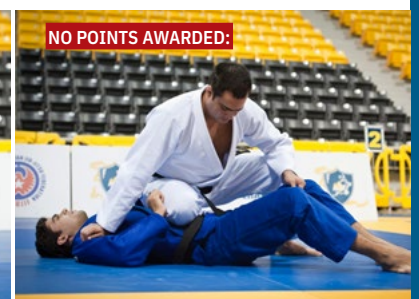
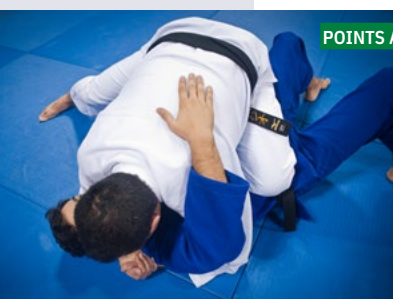

- When the athlete on top and free of the opponent's guard, places the knee or shin (closest to the opponent's hip) on the opponent's belly, chest or ribs, without the opposite knee touching the ground, maintaining the position stable for 3 seconds, while the opponent is lying on his/her back or side.

#### 4.4 Mount and Back Mount (4 points)

4.4.1 When the athlete is on top, clear of the half-guard, sitting on the opponent's torso and with two knees or one foot and one knee on the ground, facing the opponent's head and with up to one arm trapped under his/her leg – and thus remains for 3 (three) seconds.

- Should the athlete have one of the opponent's arms trapped under his/her leg, he/she shall only be awarded points for the mount if the leg trapping the arm does not extend beyond the opponent's shoulder.
- When the athlete lands on top with a triangle fastened around the opponent on bottom, no points shall be awarded for the mount.
- In the case of the mount, when there is a transition straight from back mount to mount or vice-versa –for being distinct positions– athletes shall be awarded four points for the first mount and another four points for the subsequent mount, so long as the three-second stabilization period was achieved in each position.

#### POINTS AWARDED:

TYPICAL MOUNTED POSITION



MOUNTED POSITION WITHOUT THE FEET TOUCHING THE MATS OR GROUND



SIDEWAYS MOUNTED POSITION



MOUNTED POSITION OVER ONE ARM



BACK MOUNT



TECHNICAL MOUNTED POSITION

#### ADVANTAGE

MOUNTED POSITION OVER BOTH ARMS



#### NO POINTS AWARDED:

BACKWARDS MOUNTED POSITION



#### 4.5 Back Control (4 points)

- When the athlete takes control of the opponent's back, placing his/her heels between the opponent's thighs without crossing his/her legs and in a position to trap up to one of the opponent's arms without trapping the arm above the shoulder line – and thus remains for 3 (three) seconds.

##### POINTS AWARDED:



TYPICAL BACK CONTROL



BACK CONTROL WITH ONE ARM TRAPPED

##### ADVANTAGE

BACK CONTROL WITH LEGS IN FIGURE-FOUR TRIANGLE



BACK CONTROL WITH FEET CROSSED



BACK CONTROL WITH BOTH ARMS TRAPPED

#### 4.6 Sweep (2 points)

- 4.6.1 When the athlete on bottom with the opponent in his/her guard or half-guard inverts the position, forcing the opponent who was on top to be on bottom – and maintains him/her in this position for 3 (three) seconds.



- 4.6.2 When the athlete on bottom with the opponent in his/her guard or half-guard inverts the position and the opponent turns his/her back on all fours and the athlete who initiated the reversal controls the opponent's back without the requirement of placing hooks and keeping at least one of the opponent's knees on the ground for 3 (three) seconds.



- 4.6.3 When the athlete on bottom with the opponent in his/her guard or half-guard gets to his/her feet, puts the opponent down and maintains the grips necessary to hold the opponent in bottom position for 3 (three) seconds.

*\* The examples above are merely illustrative and do not represent the full array of situations that may warrant points in each combat situation.*

## **5** ARTICLE 5 – ADVANTAGES

- 5.1** An advantage-point is counted when an athlete achieves a point-scoring pass position requiring 3 (three) seconds of control but is unable to maintain control for the entire duration.
- 5.2** An advantage is characterized by near-completion of a point-scoring position. The referee should assess whether the opponent was in any real danger and if the athlete clearly came close to reaching the point-scoring pass position.
- 5.3** The athlete shall be awarded an advantage-point when he/she attempts a submission hold where the opponent is in real danger of submitting. Again, it is the referee's duty to assess how close the submission hold came to fruition.



NOT AT REAL RISK

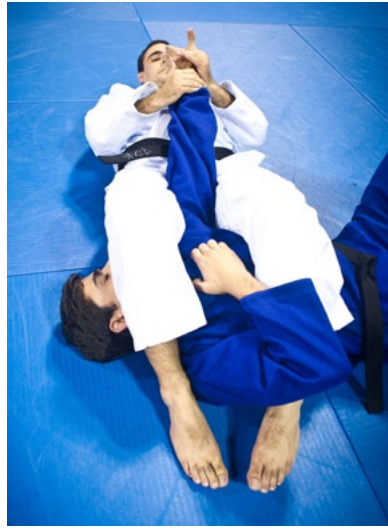

AT REAL RISK

- 5.4** An advantage point may be awarded by the referee even after a match has run its course but before announcing the result.
- 5.5** The referee may only award an advantage point once there is no longer a chance of the athlete reaching a point-scoring position.
- 5.6** Examples of Advantage Points\*

### 5.6.1 Advantage from takedown

- When an athlete achieves a takedown and his/her opponent lands back-down, sideways or in sitting position on the ground without stabilizing the position for 3 (three) seconds.
- When an athlete applies a takedown or series of takedowns and the opponent returns to their feet before stabilization is achieved on the ground. The advantage shall only be awarded when there is no longer a possibility of completing the takedown attempt, in accordance with items 3.4 and 5.5.

### 5.6.2 Advantage from Guard Pass

- When the athlete passing guard stacks the opponent, or allows the opponent to roll back his/herself, controlling the opponent's back in four-point-kneeling position and maintaining at least one knee on the ground, without needing to place hooks.
- When starting from guard (or from pulling guard) the athlete achieves half-guard control over the opponent, but does not solidify the pass in the ensuing sequence, in accordance with article 5.5.



5.6.3 Advantage from knee on belly.

- When an athlete places a knee on his/her opponent's belly but only places the knee and not foot of his/her other leg on the ground.

5.6.4 Advantage from the Mount

- When the athlete on top and free of guard or half-guard tries to sit on the opponent's torso and keeps two knees or one foot and one knee on the ground while facing the opponent's head but with both the opponent's arms trapped under his/her legs.

5.6.5 Advantage from Back Control.

- When an athlete mounts his/her opponent's back and places his/her heels between the opponent's thighs but traps both the opponent's arms.
- When an athlete mounts his/her opponent's back but crosses his/her legs, fastens a figure-four around the waist or only places one heel between the opponent's thighs.

5.6.6 Advantage from Sweep.

- When the athlete unbalances the opponent through a sweep attempt and reaches top position, but is unable to stabilize the position for 3 seconds.

*\* The examples above are merely illustrative and do not represent the full array of situations that may warrant advantage points.*

**5.7 Specific cases whereby advantages are no longer awarded.**

5.7.1 The half-guard position shall not count as an advantage for the athlete on top if he/she completes the guard pass sequence, according to article 5.5.

5.7.2 The half-guard position shall not count for an advantage for the athlete on top if it did not originate from a guard-pass attempt.

5.7.3 Athletes who suffer a takedown from the opponent and manage to roll to top position shall no longer be awarded an advantage point by the referee.

5.7.4 The athlete who initiates a sweep movement, but deliberately gives up the top position in order to preserve a defensive position, shall not be awarded an advantage for the sweep.

5.7.5 No advantages will be awarded for sweeps that start and end in a 50/50 guard situation.

5.7.6 No advantage shall be awarded when an athlete attempting a single-leg takedown traps the opponent's leg and drags the opponent to outside the combat area, obliging the referee to interrupt the combat.

5.7.7 No advantage shall be awarded when an athlete attempting to complete a sweep movement leads the opponent to fall outside the match area without ever landing on top at any moment during the movement.

## **6 ARTICLE 6 – FOULS**

Fouls are disciplinary or technical infractions addressed in the rules that are committed by athletes before, during or after a match.

### **6.1 Disciplinary Penalties**

- 6.1.1 When an athlete directs profane language or obscene gestures at his/her opponent, the center table, table officials, referee or public, prior to, before or after a match.
- 6.1.2 When an athlete exhibits hostile behavior towards an opponent, referee or any other member of the organizing committee or public, prior to, before or after a match.
- 6.1.3 When an athlete bites, pulls hair, strikes or applies pressure to the genitals or eyes, or intentionally uses a traumatic blow of any kind (such as punches, elbows, knees, head butts, kicks, etc).
- 6.1.4 When an athlete exhibits offensive or disrespectful behavior towards an opponent or the public through words or gestures during a match or in celebrating victory.
- 6.1.5 When one or both of the athlete's disregard the seriousness of the competition or perform actions simulating a fake combat.
- 6.1.6 When the athlete exhibits attitudes considered incompatible with the competition environment, or commits any other misconduct or delict, even if it is carried out prior to or following the match.

### **6.2 Technical Penalties**

Technical penalties are divided into:

- » **Lack of Combativeness**
- » **Serious Penalties**
- » **Severe Penalties**

#### **6.2.1 Lack of Combativeness**

Classified similarly to serious penalties, lack of combativeness entails:

- A) Lack of combativeness (stalling) is defined by one athlete clearly not pursuing positional progression in a match and also when an athlete impedes his/her opponent from carrying out said progression.
- B) When neither athlete demonstrates combativeness simultaneously during a combat situation.
- C) When both athletes pull guard at the same time, the referee will start a 20 second countdown. If at end of this 20 second countdown, even if the athletes are moving, one of the athletes does not reach the top position, does not have a submission in hold, or is not imminently completing a point scoring move, the referee will stop the fight and give a penalty to both athletes. In this situation, the referee will restart the combat in standing position.
- D) Lack of combativeness (stalling) is not declared when an athlete is defending his/herself from an opponent's attacks from mount, back-control, side-control or north-south positions.
- E) Will not be considered lack of combativeness when an athlete is in mount or back position, as long as the characteristics of the technical position are respected.

Examples of situations constituting lack of combativeness (stalling):\*

- When an athlete, upon achieving side-control or north-south positions over an opponent, does not seek positional progression.
- When an athlete in an opponent's closed guard does not seek to pass guard and at the same time prevents the opponent from seeking positional progression from guard.
- When the bottom athlete playing closed guard wraps his/her arms around the opponent's back or performs any other controlling movement clutching the opponent to him/her without intending to achieve a submission or score.
- When an athlete on foot grabs and maintains his/her hand on the opponent's belt, preventing the opponent from completing a takedown movement and without attempting an attack of any kind.

*\* The aforementioned examples are merely illustrative and do not represent all the situations that may be deemed lack of combativeness (stalling).*

#### 6.2.2 Serious Fouls

- A) When the athlete kneels or sits (remaining in the position) or pulls guard, without the establishment of a grip.
- B) When a standing athlete flees the bounds of the match area, avoiding combat with the opponent.
- C) When a standing athlete pushes his/her opponent to outside the match area without clear intent of attempting a submission or scoring.
- D) When an athlete on the ground evades combat by sliding his/herself outside the match area.
- E) When an athlete on the ground stands to escape combat and does not return to combat on the ground.
- F) When an athlete breaks the grip of the opponent pulling guard and does not return to combat on the ground.
- G) When an athlete intentionally removes his/her own Gi or belt, causing the match to be stopped.
- H) When an athlete grabs the opening of the opponent's sleeve or pant leg with the fingers placed inside the garment, even if performing a sweep or any other maneuver.
- I) When an athlete grabs the inside of the opponent's Gi top or pants, when he steps inside the Gi jacket and when an athlete passes a hand through the inside of the opponent's Gi to grip the external part of the gi.
- J) When an athlete communicates with someone, orally or through gestures, in a manner that contradicts a decision made by the referee.
- K) When an athlete disobeys a referee order.
- L) When an athlete exits the mat area after a match but before the referee has announced the result.
- M) When the athlete deliberately runs away from the fight area to avoid an inferior position or consolidation of the opponent's score.\*

*\* Exclusively in this case, the referee must mark the athlete who fled the match area with a penalty and award their opponent with 2 points on the scoreboard. The marked penalty must follow the sequence of penalties.*

- N) For Jiu-Jitsu No-Gi, when an athlete grabs hold of his/her uniform or that of his/her opponent in any way.
- O) When an athlete places a hand or foot on his/her opponent's face.

- P) When an athlete intentionally places his/her foot in his/her opponent's belt.
- Q) When the athlete purposely places his/her foot on the lapel of his/her opponent's Gi without having a hand grip to provide traction for his/her foot.
- R) When an athlete places a foot in the lapel behind the opponent's neck, with or without gripping it.
- S) When an athlete uses his/her own belt or the opponent's belt to assist in a choke or any other circumstance in a match while the belt is untied.
- T) When an athlete takes more than 20 seconds to re-adjust their(his/her) uniform, they shall be penalized in a consecutive manner (20 seconds for Gi top and belt, 20 seconds for identification belt, and 20 seconds for tying the drawstring of the pants, when necessary).
- U) When an athlete runs around the match area and does not engage in the combat.
- V) When an athlete unintentionally reacts in a way that places his/her opponent in an illegal position.
- W) When, in the under-15-year-old-division (for all belts) and in all white belt age groups, an athlete jumps for closed guard on a standing opponent, including any and all attacks initiated by jumping guard, such as but not limited to Flying Triangles and Flying Armbars. When such moves occur, the referee will stand both athletes up again.

*Note: Should one athlete be defending an attempted takedown or sweep and jump guard, the punishment shall include 2 points being awarded to the opponent.*

- X) When an athlete during a match or celebrating victory before being announced as the winner exhibits attitudes not appropriate for the competition environment, but does not qualify as a disciplinary penalty as described in item 6.1.

*Ex: Gestures or exercises meant to suggest physical superiority, dances or attitudes meant to ridicule within a sporting context.*

### 6.2.3 Severe Foul

- A) When an athlete's Gi is rendered unusable and he/she is unable to exchange it for a new one within a period of time stipulated by the referee.
- B) When an athlete deliberately flees the match area to avoid submitting to a submission hold applied by his/her opponent.
- C) When being attacked by a submission hold an athlete commits a penalty that obliges the referee to interrupt the match.
- D) When an athlete intentionally attempts to get his or her opponent disqualified by reacting in a way that places his or her opponent in an illegal position.
- E) When it comes to a referee's attention that an athlete is not wearing an undergarment under his or her uniform as outlined in item 8.3.10 of this Rules Book.
- F) When an athlete applies creams, oils, gels or any slippery substance to any part of the body.
- G) When the athlete utilizes any substance that increase the adherence in any part of his/her body.
- H) When the athlete utilizes any substance that makes the kimono slippery for the grips.
- I) When an athlete strangles his or her opponent ,without using the gi, with one or both hands around the opponent's neck or applies pressure to the opponent's windpipe using the thumb.

- J) When an athlete blocks the passage of air to his/her opponent's nose or mouth using his/her hands.
- K) When the athlete who is defending a single leg takedown, while the athlete attacking has his head outside his opponents body, intentionally projects his attacker to the ground, by grabbing his opponents belt, to make him hit the floor with the head (picture 25).
- L) The suplex movements that will project or force the opponent's head or neck into the ground.

*Obs: The suplex takedown is defined by the attacking athlete lifting the opponent at the waist in order to take him/her down, by throwing him backwards or sideways to the ground. The use of this technique is still permitted provided that the movement does not force the opponent's head or neck into the ground.*

- M) When an athlete applies a hold prohibited for his/her respective division, as indicated in the following table.\*

**TABLE: Technical Fouls – Illegal Moves**

	4 to 12 years old	13 to 15 years old	16 & 17 years old (all ranks) and white belts (Adult to Master 7)	Adult to Master 7 (blue & purple belts)	Adult to Master 7 (brown & black belts) except Adult No Gi	Adult (brown & black belts) No Gi	
1	●						Submission techniques stretching legs apart
2	●	●					Choke with spinal lock
3	●	●					Straight foot lock
4	●	●					Forearm choke using the sleeve (Ezequiel choke)
5	●	●					Frontal guillotine choke
6	●	●					Omplata
7	●	●					Triangle (pulling head)
8	●	●					Arm triangle
9	●	●	●				Lock inside the closed guard with legs compressing kidneys or ribs
10	●	●	●				Wrist lock
11	●	●	●				Single leg takedown while the attacking athlete has his head outside his opponents body. (**)
12	●	●	●	●			Bicep slicer
13	●	●	●	●			Calf slicer
14	●	●	●	●			Knee bar
15	●	●	●	●			Toe hold
16	●	●	●	●	●		Heel hook
17	●	●	●	●	●		Locks twisting the knees.
18	●	●	●	●	●		Knee Reaping (See definition in page 32)
19	●	●	●	●	●		In straight foot lock, turning in the direction of foot not under attack.
20	●	●	●	●	●		In toe hold, applying outward pressure on the foot
21	●	●	●	●	●	●	Slam
22	●	●	●	●	●	●	Spinal lock without choke
23	●	●	●	●	●	●	Scissor Takedown
24	●	●	●	●	●	●	Bending fingers backwards
25	●	●	●	●	●	●	Grab the opponents belt and throws him to the floor on his head when defending a single leg situation while his opponents head is on the outside of his body.
26	●	●	●	●	●	●	Suplex takedown technique, landing with the opponent's head or neck on the ground.

\* The images shown on the list are examples of prohibited techniques and do not represent the full array of prohibited technical situations and variations.

\*\* Although it is a prohibited technique, the athlete will not be penalized.

TECHNICAL FOULS – ILLEGAL MOVES

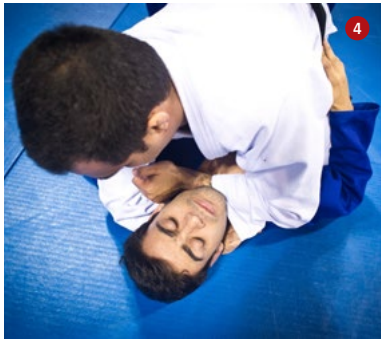

TECHNICAL FOULS – ILLEGAL MOVES



20 SEE DEFINITION IN PAGE 32



**20 Knee Reaping**

Knee reaping is characterized by when one of the athletes places his thigh behind the leg of his opponent and passes his calf on top of the opponent's body above the knee, placing his foot beyond the vertical midline of the opponent's body and applying pressure on his opponents knee from the outside, through inside, while keeping the foot of the leg at risk trapped between his hip and armpit.

It is not necessary for one of the athletes to hold the foot of his opponent in order for the foot to be considered trapped.

For purposes of this rule, when one athlete is standing and bearing their weight on foot of the same leg as the knee in danger, the foot will be considered trapped.

**For Purple Belt Athletes and below**

When the two athletes are seated with their legs crossed but in a legal position as illustrated by **image 1**, and one of the athletes stands up, causing the opponent from below to be in an illegal position as illustrated by **image 2**. This is because when standing up, the foot that was loose and now stepping on the ground is considered a trapped foot.

In this situation, the referee must stop the fight, then place athlete B in a sitting position and athlete A standing at a sufficient distance to allow new grips and then continue the fight.



IMAGE 1



IMAGE 2

If the situation shown in **image 2** occurs after a sweep, the referee must wait 3 seconds to define the stabilization, and in sequence; stop the fight; award 2 points for athlete A who is on top, place athlete B in a sitting position and athlete A standing at a sufficient distance to allow new grips and continue the fight.

**For Brown and Black Belt athletes:**

The referee will not interrupt the fight. No penalty will be applied exclusively in this case.

**Severe Foul**

- When the athlete executes the movement in the characteristics mentioned above, with their foot crossing the opponent's body limit.





- When either of the athletes have a submission hold, it will be considered a severe foul for the athlete crossing his foot in the characteristics mentioned above.

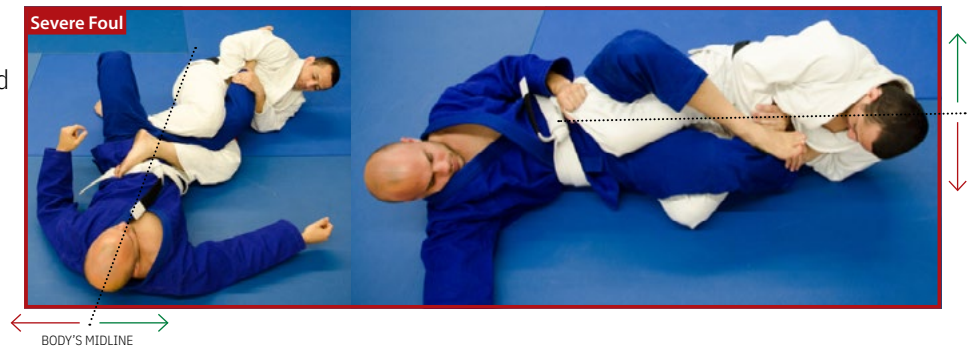

50/50 GUARD

- When the athlete turns inside from a 50/50 guard and at the beginning of the turn his opponent is stepping on the ground with the foot that is on the guard, it 's considered a trapped foot (as shown in the image on the right)



### Serious Foul

- When the athlete executes the movement in the characteristics mentioned above, moving his foot across the vertical midline of the opponent's body. The referee shall stop the match, return the position if permitted and issue a penalty to the athletes before restarting the fight.

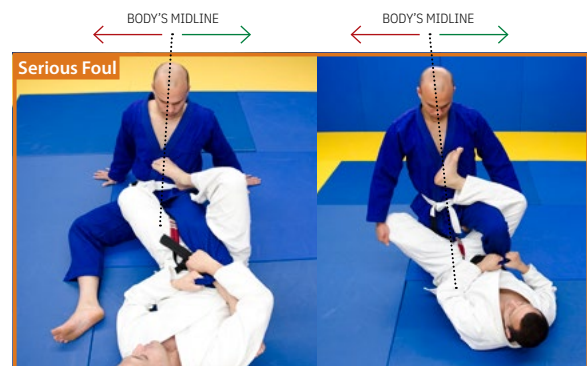

### Normal Situations

Not considered fouls:

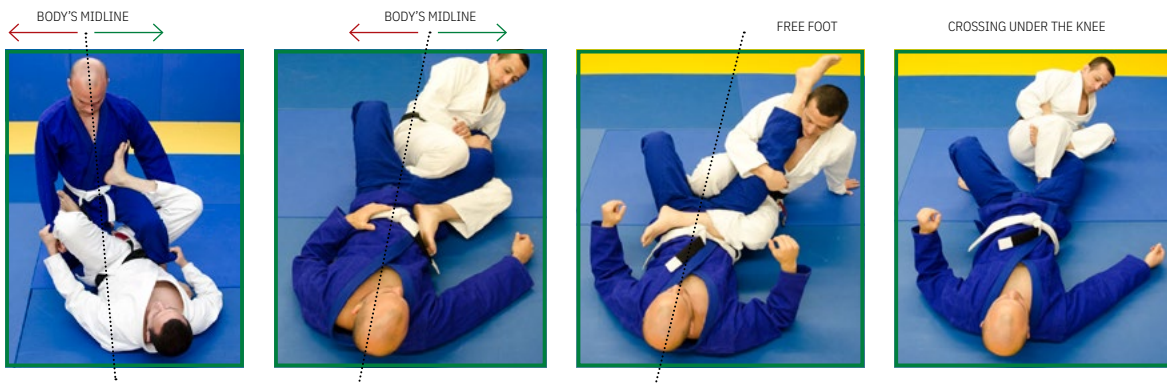

## **7** ARTICLE 7 – PENALTIES

Penalties are awarded by referees with the aim of assuring the match flows properly and that the rules of the sport and the competition are being respected.

- » **Severe Fouls**
- » **Serious Fouls**
- » **Penalties for Lack of Combativeness**

### **7.1** **Severe Penalties**

- » **Technical Penalties:** Summary disqualification from the match at the moment of the infraction.
- » **Disciplinary Penalties:** Summary disqualification from the match and competition at the moment of the infraction.

### **7.2** **Serious Penalties**

7.2.1 Referees shall abide by the following series of penalties.

- 1st PENALTY – The referee will mark the first penalty for the athlete.
- 2nd PENALTY – Advantage point concession to opponent of penalized athlete and second penalty marked on scoreboard for perpetrating athlete.
- 3rd PENALTY – Two points concession to opponent of penalized athlete and third penalty marked on scoreboard for perpetrating athlete.

*Note: In situations whereby both athletes are penalized for lack of combativeness resulting in a third penalty for each, the match shall be restarted standing.*

- 4th PENALTY – Disqualification of perpetrating athlete.\*

7.2.2 Serious penalties are cumulative between them and different fouls will bring into effect the escalating penalty sequence addressed in clause 7.3.1.

7.2.3 If the athlete has already received penalties for lack of combativeness on the scoreboard, these penalties will be added to the penalties for serious fouls.

7.2.4 In the under-15-year-old divisions, on an athlete's fourth and fifth fouls the referee shall award two points to the opponent and one penalty point to the perpetrating athlete for each penalty. Only on the sixth penalty shall the referee disqualify the perpetrating athlete.

### **7.3** **Penalties for lack of combativeness**

7.3.1 The penalties for lack of combativeness will follow the sequence below after the referee considers one or both athletes been under the situations described in item 6.2.1.

- The referee shall count 20 (twenty) consecutive seconds and, in accordance of 1.4.1, signal lack of combativeness with the verbal command "Lute," referring to the penalty to be applied to the athlete, in accordance with the sequence described in item 7.2.

7.3.2 If the athlete has already received penalties for serious fouls on the scoreboard, these penalties will be added to the penalties for lack of combativeness.

## **8** ARTICLE 8 – OBLIGATIONS, BANS, AND DEMANDS

### **8.1** **Gis and Uniforms**

- 8.1.1 Gis should be tailored using cotton or cotton-like fabric. The fabric should not be so thick or hard as to impede an opponent from gripping it. For juvenile, adult and master divisions, a Gi fashioned from woven fabric(pearl weave) is mandatory.
- 8.1.2 It is permitted to wear kimono with EVA or similar material inside the collar, if the measures of size and rigidity regulations provided in this Rules Book are followed.
- 8.1.3 The Gi should be completely white, royal blue or black. No Gi's will be accepted with different colored jackets or pants nor will we allow the use of Gis with different colored collars. It is not allowed for athlete's to wear shirts beneath their Gi (except for females, which must comply with item 8.1.4).
- 8.1.4 In the female divisions, it is mandatory for the use of a stretchy or elastic shirt that hugs the body beneath the Gi; It can be short or long sleeved, without the necessity to follow the color requirements. It is also permitted for athlete's to use a one piece swim garment (bathing suit) or gymnastics top.
- 8.1.5 In the adult black belt divisions (mens and women's), the event's organizers may demand that athletes have two gis of different colors (one royal blue and the other white), in order to distinguish between the two athletes in a match.
- 8.1.6 Gis may not exhibit mending or tears, be wet or dirty or emanate unpleasant odors.
- 8.1.7 The Gi top should reach the athlete's thigh and the sleeves should come to no more than 5 cm from the athlete's wrist when the arm is extended straight parallel to the ground.
- 8.1.8 Gi pants should reach no more than 5 cm above the tibial malleolus (ankle bone). For male divisions, wearing pants of any kind under the Gi pants is prohibited. For female divisions, it is permitted for the use of elastic fabric pants (that clings to the body) under the Gi pants, as long as they are shorter than the Gi pants.
- 8.1.9 Athletes should use a durable, 4-to-5 cm-wide belt colored according to the athlete's rank, with a black tip – except for black belts, where the tip should be white or red. The belt should be worn over the top, wrap around the waist twice, and be tied using a double knot tight enough to hold the Gi top closed. Once tied in a double knot, each end of the belt should hang 20 to 30 cm in length.
- 8.1.10 Painted gis are forbidden, unless the paint is designed in the form of an academy or sponsor logo – and only on regions of the Gi where patches are permitted. Even in cases where they are permitted, the athlete will be obliged to change gis should the paint mark the Gi of the opponent.
- 8.1.11 Prior to weighing in, the inspector will verify that the specifications of the uniform meet regulations.
- At final inspection the following measurements will be checked to make sure they are in accordance with the required standard: length of sleeves and pant legs, maximum thickness of Gi collar (1.3 cm); maximum width of Gi collar (5 cm); maximum slack in Gi sleeves throughout entire extension (7 cm);
  - Every athlete is entitled to 3 (three) uniform inspections for approval.
  - The Uniform Inspector will also verify the overall state of the athlete's belt.

8.1.12 The uniform measuring tool will have the following regulated measurements:

**Total length of measuring tool:** 15 cm

**Measuring tool width:** 3.5 cm

**Gi lapel width:** 5 cm

**Gi lapel thickness:** 1.3 cm

**Gi sleeve opening at full extension:** 7 cm

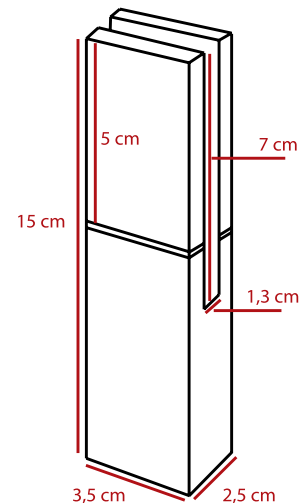

8.1.13 After weighing in, athletes may not change their gis for their first match, under penalty of disqualification.

8.1.14 Following the first match, athletes may request of the Ring Coordinator permission to change gis. The new Gi will undergo a new measurement inspection.

8.1.15 Athletes will be subject to disqualification should they not undergo a measurement inspection of their new Gi prior to the first match wearing the new gi.

8.1.16 For Jiu-Jitsu No-Gi, athletes should abide by the following attire requirements:

- Shirts and Rash Guards:

Both genders must wear a shirt of elastic material (skin tight) long enough to cover the torso all the way to the waistband of the shorts, colored black, white, or black and white, and with at least 10% of the rank color (belt) to which the athlete belongs. Shirts 100% the color of the athlete's rank (belt) are also permitted.

*Note: For black belts a small red area will be tolerated, but must not decharacterize the athlete's rank color.*

- Shorts for men:

Board shorts colored black, white, black and white, and/or the color of the rank (belt) to which the athlete belongs, without pockets or with the pockets stitched completely shut, without buttons, exposed drawstrings, zippers or any form of plastic or metal that could present a risk to the opponent, long enough to cover at least halfway down the thigh (no more than 15 cm from the knee), and no longer than the knee.

Also permitted are compression shorts made of elastic material (skin tight) worn beneath the shorts, in the colors black, white, black and white, and/or the color of the rank (belt) to which the athlete belongs.

- Shorts, compression shorts and pants for women:

Shorts, compression pants (skin-tight spats) and/or compression shorts colored black, white, black and white, and/or the color of the rank (belt) to which the athlete belongs. The shorts must not have pockets or have the pockets stitched completely shut, must not have buttons, zippers or any kind of plastic or metal that could present a risk to the opponent, and must be long enough to cover halfway down the thigh (no more than 15 cm from the knee) and no longer than the knee.

## **8.2** Hygiene

8.2.1 Athletes' finger and toenails should be trimmed and short.

8.2.2 Long hair should be tied up so as not to cause opponents any discomfort.

8.2.3 Athletes will be disqualified if they are wearing hair dye that stains their opponents' Gi during a match.

8.2.4 Athletes should use footwear up to the match area and wherever their use is permitted.

8.2.5 Following weigh in, the Gi Inspector should check athletes for any skin conditions.

- Athletes presenting skin lesions noticed by the inspector shall be directed to the event's medical area.
- Athletes should present a statement from a doctor declaring the lesion not contagious and not harmful to other competitors.
- For the organizers of the event, the tournament medic has the final say on whether to allow an athlete to compete or not.

### 8.3 Further Requirements

8.3.1 Each athlete shall only mount the official scale of the event to have his/her weight taken once.

8.3.2 Athletes are allowed to weigh in without knee or elbow braces, but they will have to be wearing them at the time of the Gi inspection.

8.3.3 The athlete cannot step on the scale with shoes or any item besides his/her regular uniform and equipment permitted for use during matches.

8.3.4 Patches and embroiders can only be affixed in authorized regions of the gi, as depicted in the illustrations below. They should be of cotton fabric and properly seamed. All patches unseamed or in unauthorized regions of the Gi will be removed by the Gi inspectors.

8.3.5 Prohibitions regarding patches and text present on uniform:

- No patches or text (embroidered or handwritten) will be allowed related to political ideologies and phrases, symbols or slogans found offensive to gender, sexual orientation, ethnicity, culture, religion.
- No patches or text (embroidered or handwritten) will be allowed that contain phrases, symbols or slogans that promote violence, vandalism, sexual acts, drugs, alcohol and/or tobacco.

8.3.6 Permitted: a Gi brand tag in the front lower part of the pants (according to illustration). The tag must be made of a thin fabric (not embroidered) and be at most 36 cm<sup>2</sup>.

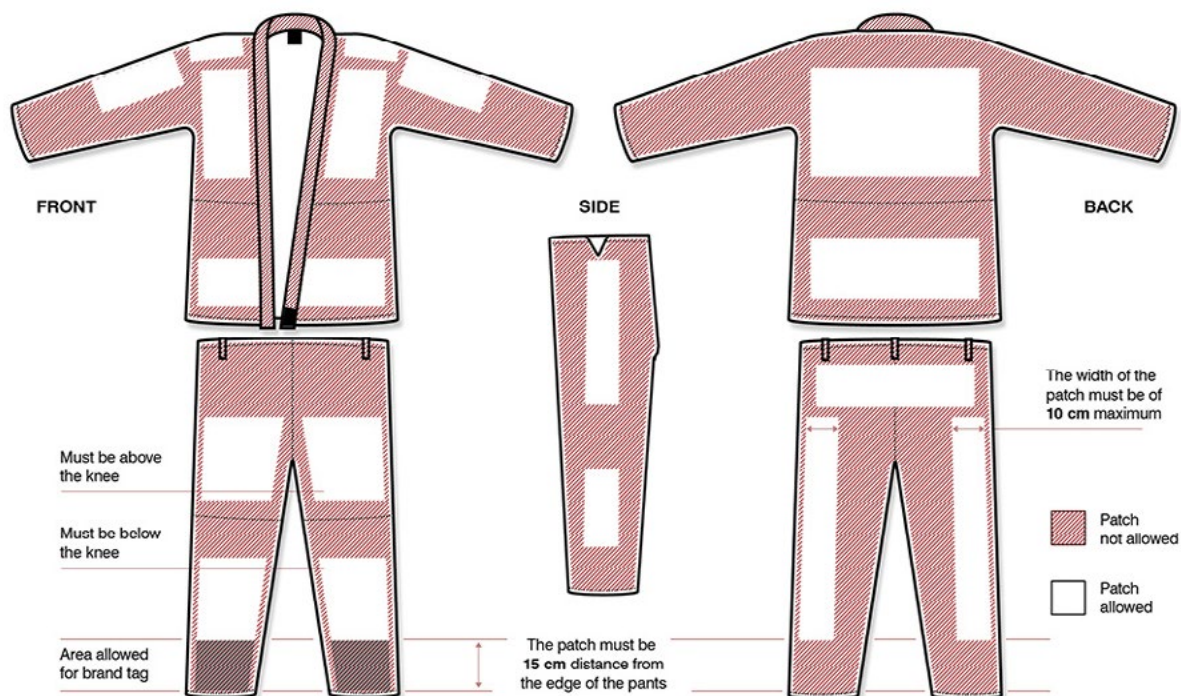

- 8.3.7 Use of any foot gear, headgear, hair pins, jewelry, cups (genital protectors), or any other protector fashioned of hard material that may cause harm to an opponent or the athlete him/herself is forbidden. Also forbidden is the use of eyes protectors, even if they are made for sports practices.
- 8.3.8 In the female divisions, the athlete will be permitted to cover their heads. The Head Cover must follow these requirements.
- Must be fixed and made with elastic fabric(or have elastics at the borders).
  - Be made without any kind of plastic or hard materials.
  - Be made with no strings of any kind.
  - Be clear of any inscription or logo.
  - Must be totally black, white, black and white, and/or the color of the rank (belt) to which the athlete belongs.
  - Also permitted as part of the female uniform is a single-piece head cover, which should be made of elastic and cover the neck, ears and completely cover the hair, similar to the head cover of a wet suit, and be entirely black, white, black and white, and/or the color of the rank (belt) to which the athlete belongs
- 8.3.9 The use of joint protectors (knee, elbow braces, etc.) that increase body volume to the point of making it harder for an opponent to grip the Gi are also forbidden.
- 8.3.10 It is mandatory that athletes wear undergarments for all competitions, regardless if it is a Gi or No-Gi event. The undergarment should be “brief-type” only. Failure to adhere of this rule will be considered a foul according to item 6.2.3(E), and the athlete will be submitted to the penalties provided at item 7.1.



## GENERAL COMPETITION GUIDELINES



## **1** ARTICLE 1 – DIVISIONS AND REGULATION MATCH DURATIONS

- 1.1** The age division to which an athlete belongs is determined by the age the athlete is or will be on the year of a given tournament.
- 1.2** There is no maximum age for the adult and master divisions, but there is a minimum age.
- 1.3** The divisions shall abide by the age limits and regulation match durations described in the table below.

WEIGHT DIVISION	AGE DIVISION	MATCH TIME PERIOD
MIGHTY MITE I	(Current Year) – (Birth Year) = 4	02 minutes
MIGHTY MITE II	(Current Year) – (Birth Year) = 5	02 minutes
MIGHTY MITE III	(Current Year) – (Birth Year) = 6	02 minutes
PEE WEE I	(Current Year) – (Birth Year) = 7	03 minutes
PEE WEE II	(Current Year) – (Birth Year) = 8	03 minutes
PEE WEE III	(Current Year) – (Birth Year) = 9	03 minutes
JUNIOR I	(Current Year) – (Birth Year) = 10	04 minutes
JUNIOR II	(Current Year) – (Birth Year) = 11	04 minutes
JUNIOR III	(Current Year) – (Birth Year) = 12	04 minutes
TEEN I	(Current Year) – (Birth Year) = 13	04 minutes
TEEN II	(Current Year) – (Birth Year) = 14	04 minutes
TEEN III	(Current Year) – (Birth Year) = 15	04 minutes
JUVENILE I	(Current Year) – (Birth Year) = 16	05 minutes
JUVENILE II	(Current Year) – (Birth Year) = 17	05 minutes
ADULT	(Current Year) – (Birth Year) ≥ 18	05 minutes – White 06 minutes – Blue 07 minutes – Purple 08 minutes – Brown 10 minutes – Black
MASTER 1	(Current Year) – (Birth Year) ≥ 30	05 minutes – White / Blue 06 minutes – Purple / Brown / Black
MASTER 2	(Current Year) – (Birth Year) ≥ 36	05 minutes
MASTER 3	(Current Year) – (Birth Year) ≥ 41	05 minutes
MASTER 4	(Current Year) – (Birth Year) ≥ 46	05 minutes
MASTER 5	(Current Year) – (Birth Year) ≥ 51	05 minutes
MASTER 6	(Current Year) – (Birth Year) ≥ 56	05 minutes
MASTER 7	(Current Year) – (Birth Year) ≥ 61	05 minutos

- 1.4** Minimum between-match rest time is described in the table below:

MATCHES UP TO SEMIFINALS	Equal to regulation match duration for respective division
FINAL MATCHES	Double regulation match time for respective division

## **2** ARTICLE 2 – BRACKETS

- 2.1** The athletes in each division shall be sorted into brackets.
- 2.2** The brackets will serve as a simple elimination system, where the losing athlete from each match is eliminated and the winner goes through to the next stage of the brackets.
- 2.3** The only exception to the simple elimination system is when there is a bracket of three (only three athletes make up the bracket).

- 2.3.1 In a bracket of three, the winner of the first match goes through to the final and the losing athlete faces the third competitor in the bracket. The athlete who wins the second match – regardless of whether it is the same athlete to lose the first match – goes through to the final to face the winner of the first match.

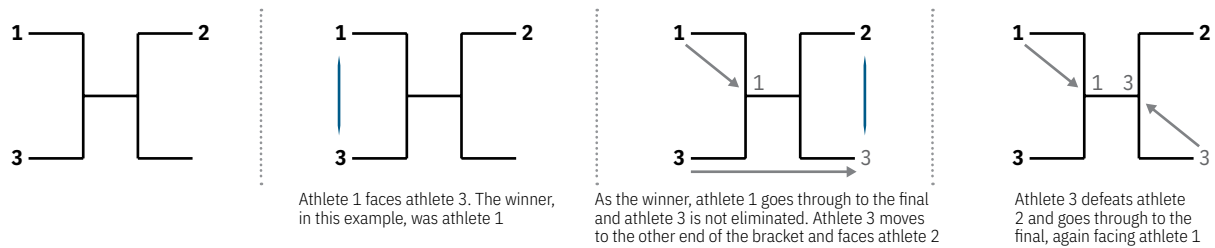

- 2.3.2 In a 3-member-bracket, if the athlete exceeds the weight limit of the division, he/she will be eliminated from the competition and he/she will have no right to fight the other semi-final.
- 2.3.3 When an athlete in a 4 member bracket is disqualified, the bracket will not adopt the 3 member bracket method.
- 2.3.4 In a 3-member-bracket semi-final, if an athlete misses his/her first fight, he/she will have no right to fight the other semi-final.

## 2.4 Disqualification in semifinals and final

### 2.4.1 Semifinals

- Should both athletes accidentally be injured in a tournament semifinal, with the score tied at the moment of the accident and neither athlete fit to continue in the match, the other semifinal will be promoted to the status of final. In this case, the injured athletes will be awarded third place.
- When both athletes in a semifinal match are disqualified via technical penalty, the other semifinal shall count as the division final. In this case, the disqualified athletes shall be proclaimed the third-place athletes.
- When both athletes in a semifinal match are disqualified via disciplinary penalty, the other semifinal shall count as the division final. In this case, the disqualified athletes shall not be proclaimed the third-place athletes, thus leaving the post vacant.
- When all four athletes in both division semifinals are disqualified via technical penalty, the four athletes who lost to them in the quarterfinals shall compete against each other in extra semifinal matches to determine the divisional finalists. In this case, all four athletes disqualified in the semifinals shall be proclaimed third-place winners – and the athletes who lost the extra semifinals shall not receive medals.
- When all four athletes in both division semifinals are disqualified via disciplinary penalty, the four athletes who lost to them in the quarterfinals shall compete against each other in extra semifinal matches to determine the divisional finalists. In this case, the disqualified semifinalists shall not receive medals – and the athletes who lost the extra semifinals shall be proclaimed third-place winners.
- When an athlete in a semi-final is disqualified before participating in a match, the quarter-final on the same side of the bracket will become the semi-final match.
- When both athletes in a semi-final match of a 3-member-bracket are disqualified by technical penalty, a random pick will take place to choose who will progress to the final. The loser of the random pick will be considered the loser of the semi-final fight.
- When a semifinal match has both athletes disqualified, one for a disciplinary penalty and the other for a technical penalty, the athlete disqualified by technical penalty will keep the third place ranking. The other semi-final will be considered the final for the division.

- In the case of there is only one qualified athlete in one of the semifinals spots, because all athletes in the qualifying matches for the other semi final spot were priorly disqualified. The loser of the quarter-final in which had a fight on the same side of the bracket will be declared third place.

#### 2.4.2 Finals

- When both athletes in a final match are disqualified via technical penalty, the athletes who lost the semifinals shall return to fight in the final. The winner of this new final will be declared first place and the loser third place. In this case, the disqualified athletes shall be proclaimed second place.
- The technical disqualification of the two athletes from a three-Member bracket final will make the loser of the second semifinal become the champion. The two disqualified athletes will be proclaimed second places
- When just one of the athletes in a final match is disqualified by disciplinary penalty, the athlete who lost to the new champion in the semi-final will be declared second place.
- When a final has both athletes disqualified, one for a disciplinary penalty and the other for a technical penalty, there will be no winner. The athlete disqualified by technical penalty will keep the second place. In this case, the losers of the semi finals will fight and the winner will be declared first place. The other athlete will keep the third place.
- When both athletes in a final match are disqualified via disciplinary penalty, the athletes who lost the semifinals shall return to dispute the final. In this case, the athletes who lost their quarter finals to the new finalists must be declared third places.
- When a final match has only one finalist because all the athletes on the opposite side of the bracket were disqualified without having made any match, the semifinal with athletes who have not been disqualified will be valid as the final of the class, and the quarterfinals as a semifinals.

### **3** ARTICLE 3 – INTER-ACADEMY CONTESTS

**3.1** The results of the three top-placing athletes shall count for points in the overall inter-academy contest for each division of the competition.

**3.2** The following points are awarded for each of the top three placements:

**Champion:** 9 points

**Runner-up:** 3 points

**Third place:** 1 point

**3.3** Tie-Breaker

3.3.1 Tie-breakers at championships where points from each age category are counted separately.

- The academy with the greatest number of gold medals shall be declared the winner.
- In the event of a draw in the number of champions, the academy with the greatest number of silver medalists shall be declared the winner.
- In the event of a draw in the number of gold and silver medalists, the academy with the greatest number of highest-ranking champions shall be declared the winner.
- In the event of a draw in the number of highest-ranking champions, the academy with the highest-ranking and heaviest champion shall be declared the winner.
- In the event of a draw in all the aforementioned scenarios, the winner shall be determined at random.

3.3.2 Tie-breaker at championships where points from two or more age divisions are counted as a whole.

- The academy with the greatest number of gold medalists shall be declared the winner.
- In the event of a draw in the number of champions, the academy with the greatest number of silver medalists shall be declared the winner.
- In the event of a draw in the number of gold and silver medalists, the academy to be declared winner will have the greatest number of black belt champions in the following age divisions in the following sequence:

Adult, Master 1, Master 2, Master 3, Master 4, Master 5, Master 6, Master 7.

- In the event of a draw in the number of black belt champions across all age divisions, the academy to be declared the winner will have the greatest number of champions at the highest belt rank in the age divisions in the following sequence:

Adult, Master 1, Master 2, Master 3, Master 4, Master 5, Master 6, Master 7, Juvenile II, Juvenile I, Teen III, Teen II, Teen I, Junior III, Junior II, Junior I, Pee Wee III, Pee Wee II, Pee Wee I, Mighty Mite III, Mighty Mite II, Mighty Mite I.

- In the event of a draw in all the aforementioned divisions, the winner shall be determined by random pick.

**3.4 Points from divisions where only one athlete signed up shall not count in the inter-academy contest.**

**3.5 Points from divisions where only two athletes from same academy signed up shall not count in the interacademy contest.**

**3.6 Team contest**

3.6.1 Should there be a draw in team scores after all the matches are over, the tied teams may pick one athlete each to compete in a decisive extra match.

## **4 ARTICLE 4 – AWARDS**

**4.1 The three top-placed athletes in each division shall receive medals on the championship's official winners' podium.**

4.1.1 For all championships, the awards shall adhere to the following norms:

- The champion shall receive a gold medal.
- The runner-up shall receive a silver medal.
- The two third-place athletes shall receive one bronze medal apiece.
- The prizes shall be awarded according to the results proclaimed by the referees. Exchanging placement at the moment prizes are awarded is expressly forbidden.
- To participate in the awards ceremony, the athlete should be wearing exclusively a Gi permitted for use in the Gi tournament or the official uniform of the Jiu-Jitsu No-Gi tournament.
- Accessories foreign to the practice of the sport are prohibited.

4.1.2 For team contests, only the top two teams shall be awarded medals on the championship's official winners' podium.

**4.2 Athletes disqualified by WO (no show) shall not be awarded a medal and their names will not appear on the championship's final placement list.**

4.2.1 The only exception to the stipulation in item 4.2 is when an athlete has competed in at least one match in the division in question.

**4.3 Athletes disqualified via disciplinary penalty shall not receive a medal and their names shall not appear on the championship's final placement list.**

**4.4 Athletes alone in a division will need to undergo the uniform inspection, weigh in and be approved, in order to receive a medal and have his/her name appear on the championship' final placement list.**

4.4.1 In the ultra heavyweight and absolute divisions, athletes alone in a division will need to undergo the uniform inspection and be approved, in order to receive a medal and have his/her name appear on the championship's final placement list.

## **5 ARTICLE 5 – REGISTRATION**

**5.1 Athletes registering for any championship must be affiliated with an academy, and that academy is subject to IBJJF approval.**

**5.2 Each academy has the right to register two athletes in each weight/belt/age/gender division.**

**5.3 The teacher responsible for each academy or association of academies has sovereign power over the registration of the athletes representing his/her academy or association of academies – and is authorized to make changes to the lineup and add or exclude athletes in all divisions, including the absolute.**

**5.4 Registration for each championship shall adhere to a timetable widely publicized by the IBJJF, and all deadlines must be enforced.**

**5.5 An athlete proven to be a black belt in judo, have experience in freestyle or Greco-Roman wrestling or to have fought MMA as a professional or amateur, shall not be allowed to enter any tournament as a white belt.**

*\* In the USA, to have competed at a college level or higher. In other countries, to have competed in events of national scope.*

**5.6 Athletes who do not meet the requirements put forth in championship guidelines or those in this General Competition Regulations Book may be disqualified at any moment prior to, during or following the competition.**

**5.7 Athletes signed in black belts divisions can only fight with the graduation that they are registered under with the IBJJF (or its affiliates) at registration.**

**5.8 The athlete may only compete as the belt they are registered under with the IBJJF (or its affiliates). If the athlete is promoted by his/her teacher before the minimum time spent in the previous belt requirement is met or minimum age, he/she cannot compete in this current belt nor the previous one.**

**5.9 Once an athlete's gradation occurs, he can not compete in his previous belt anymore. If he gets promoted during a competition after his division is done, he will be forbidden from competing in the open class.**

**5.10** IBJJF has contracted with the United States Anti-Doping Agency (“USADA”) to conduct doping control services in conjunction with its events, including sample collection and analysis, results management, and the adjudication of disputes involving potential anti-doping rule violations. It is the duty of members of the IBJJF to comply with all anti-doping rules of the World Anti-Doping Code and of the U.S. Anti-Doping Agency (USADA), including the USADA Protocol for Olympic and Paralympic Movement Testing (USADA Protocol) and all other policies and rules adopted by the IBJJF and USADA with the following modifications: First instance arbitral decisions are final and not subject to appeal to the Court of Arbitration for Sport or any other body, and USADA need only notify the athlete and IBJJF of alleged violations and case resolutions. Athletes agree to submit to drug testing by the IBJJF and/or USADA or their designees at any time and understand that the use of methods or substances prohibited by the applicable anti-doping rules make them subject to penalties including, but not limited to, disqualification and suspension. If it is determined that a member may have committed a doping violation, the member agrees to submit to the results management authority and processes of USADA, including arbitration under the USADA Protocol, or to the results management authority of the IBJJF, if applicable or referred by USADA.

## **6** ARTICLE 6 – RULES OF CONDUCT ATHLETE AND ADMINISTRATIVE PUNISHMENTS

**6.1** When an athlete removes any part of the uniform or kimono when inside the competition area.

**6.2** When the athlete jumps over the barriers that separate the competition area and the public area.

**6.3** When an athlete does not wear shoes and walks barefoot within the competition area or in other areas where it is required to wear shoes.

**6.4** When the athlete or professor displays attitudes considered incompatible with the competition environment, regardless of whether the match has not yet begun or has already ended.

*OBS: An athlete who violates one or more of the rules of conduct described in this item may receive administrative punishments to be defined according to IBJJF criteria.*

## **7** ARTICLE 7 – FURTHER PROVISIONS

**7.1** The published guidelines of each individual championship shall overrule this General Competition Regulations Book when need be.

**7.2** It is strictly forbidden for anyone from the organizing committee, performing any official function at a championship, to issue instructions to an athlete in the competition area.

**7.3** It is strictly forbidden for anyone not part of the event’s organizing committee to speak with the table officials.

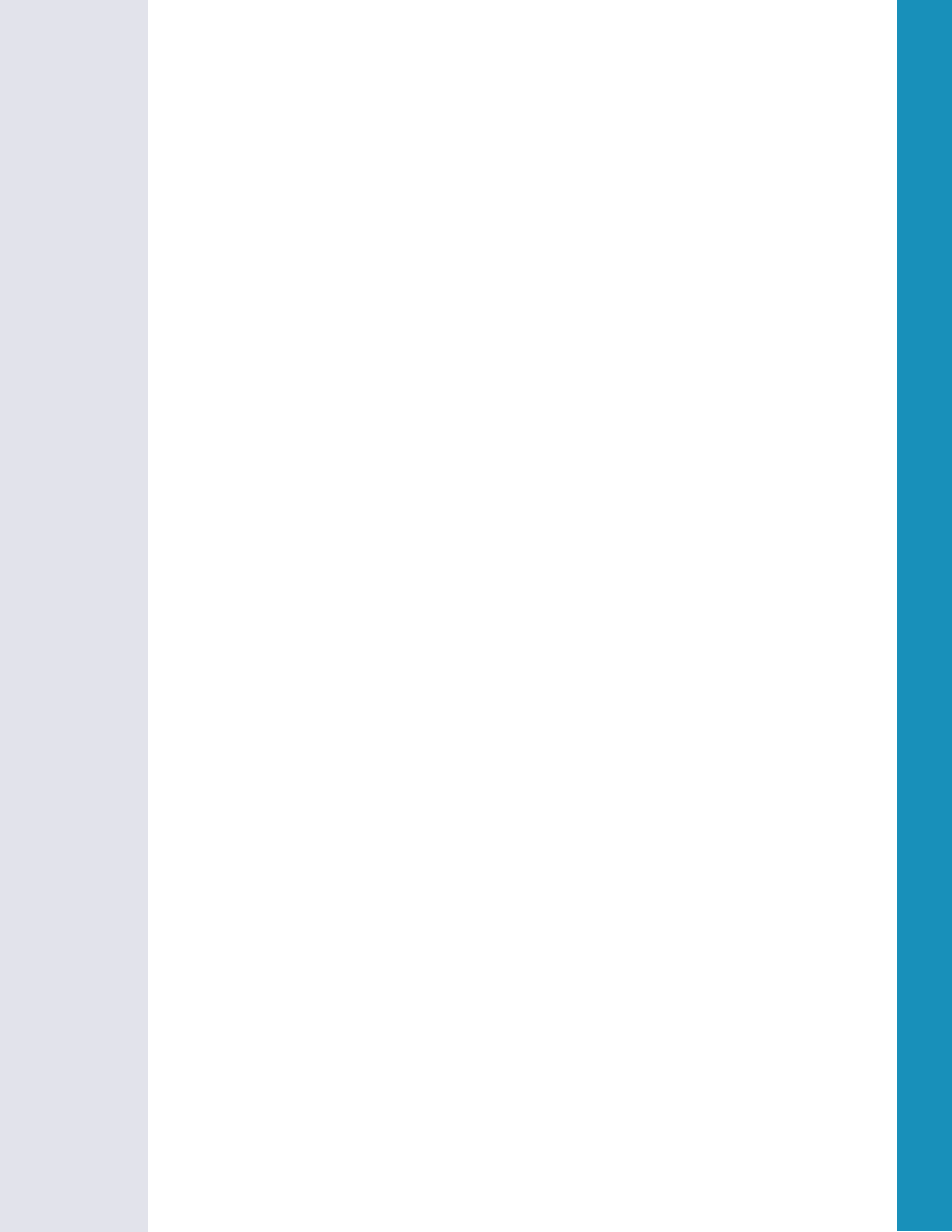

COMPETITION FORMAT MANUAL



## 1 ARTICLE 1 – COMPETITION AREA

The competition area shall be composed of one or more match areas, score tables, a warm-up area, a weigh-in area, a center table, and an awards area.

### 1.1 Match Areas

1.1.1 Match areas are composed of a combat area and an outlying safety area distinguished from each other by different colors.

1.1.2 The minimum size of a match area is 64m<sup>2</sup>, with 36m<sup>2</sup> comprising the combat area and 28m<sup>2</sup> comprising the safety area surrounding the combat area.

1.1.3 The maximum size of a match area is 100m<sup>2</sup>, with 64m<sup>2</sup> comprising the combat area and 36m<sup>2</sup> comprising the safety area surrounding the combat area.

1.1.4 A 64m<sup>2</sup> match area assembled using 2- by 1-meter segments is to be configured in the following manner:

- 18 segments in the combat area.
- 14 segments in the safety area.

64 m<sup>2</sup> AREA

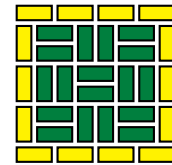

A 100m<sup>2</sup> match area assembled using 2- by 1-meter segments is to be configured in the following manner:

- 32 segments in the combat area.
- 18 segments in the safety area.

100 m<sup>2</sup> AREA

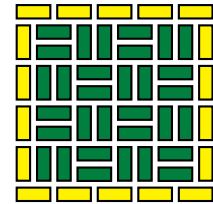

### 1.2 Score-keeping tables

1.2.1 Shall be composed of one table and one or two chairs, placed in front of each match area.

1.2.2 Each table should clearly display the number of the corresponding match area and contain two scoreboards and one clock. In special cases, an electronic scoreboard may be used in place of the manual scoreboards and clock.

1.2.3 The scoreboard is to be configured as follows:

4	3	2	1	1
MOUNT BACK CONTROL	GUARD PASS	TAKEDOWN SWEEP KNEE ON BELLY	PENALTIES	ADVANTAGES

1.2.4 The manual scoreboard shall be placed on the table in such a way that the green-and-yellow half is on the right of the referee when he/she is in front of the score-keeping table.

### **1.3 Warm-Up Area**

- 1.3.1 A cordoned-off area adjacent to the competition area, exclusively for athlete use.
- 1.3.2 The championship organizing committee shall summon the athletes of each division to the warm-up area as pre-determined by the event timetable.
- 1.3.3 It is at this location and only at this location that Ring Coordinators will direct athletes to the match areas.
- 1.3.4 It is up to the event organizing committee whether a scale will be provided in the warm-up area for athletes to check their weight prior to the official weigh-in.

### **1.4 Weigh-in and Uniform-Inspection Area**

- 1.4.1 Athletes' gis shall undergo an inspection for size, patch placement, hygiene, belt, and overall condition.
- 1.4.2 The weigh-in area should include at least one scale with which to determine athlete weight.

### **1.5 Center Table**

To be placed at a location central to all match areas. From there the brackets will be distributed to Ring Coordinators and results diagrams will be drawn up in order to award athletes their medals.

### **1.6 Podium**

To be composed of three levels: the highest level for first-place athletes; the second highest (on the right of first-place) for second-place athletes; and the lowest (on the left of the first-place) for third-place athletes.

## **2** ARTICLE 2 – STAFF AND THEIR DUTIES

### **2.1** **General Director of Competition:**

oversees the overall competition and makes final decisions regarding any issues pertaining to event organization and progress.

### **2.2** **Ring Coordinator Supervisor:**

oversees all the work performed by Ring Coordinators, making sure they are properly keeping up with bracket progression. They help the center table to distribute, collect and match brackets.

### **2.3** **General Director of Refereeing:**

selects referees and rotates them throughout the event. He/she guides and issues a technical evaluation of the referees at the end of each competition day.

### **2.4** **Center Table Coordinator:**

distributes the brackets, conveys results to the center table, and is responsible for registration control and bracket planning for the absolute division.

### **2.5** **Center Table Assistant:**

provides assistance to the Center Table Coordinator and records the results from each bracket delivered by the Ring Coordinator.

### **2.6** **Referee:**

judges each match.

### **2.7** **Ring Coordinator:**

receives the brackets from the center table, summons the athletes to the warm-up area, checks their IDs, ushers them to the uniform inspector, weighs them before first match, directs them to the match area, and following the match records the result in the bracket. After a bracket has come to a close, he/she returns the bracket to the center table.

### **2.8** **Table Official:**

records the points, advantages and penalties signaled by the referee on the scoreboard, keeps match time, and announces the end of the match using a whistle.

### **2.9** **Uniform Inspector:**

inspects each athlete's uniform to verify whether the uniform conforms to the specifications in size, cleanliness and appearance, position of patches, and overall general condition.

### **2.10** **Awards Team:**

calls the medalists to the podium and delivers medals to the medalists from each division.

### **2.11** **Announcer:**

announces the divisions over the loudspeaker and makes miscellaneous announcements throughout the competition.

*Note: in case of any doubt, refer to portuguese version.*

2014-2021©INTERNATIONAL BRAZILIAN JIU-JITSU FEDERATION (IBJJF)

RIO DE JANEIRO, BRAZIL  
JANUARY 2021

Photos: Dan Rod/Ivan Trindade  
Design & Illustration: gruzman.design

**VERSION 5.2**



**IBJJF**

INTERNATIONAL BRAZILIAN JIU-JITSU FEDERATION

[www.ibjjf.com](http://www.ibjjf.com)